



Shooting Star

EVS

ENVIRONMENTAL STUDIES

SR KG BOOK - 1



Preface

Our world is a beautiful place. It is our duty to preserve and take care of the planet we live in. Unless our little ones know about the world they live in, they would not be able to appreciate the beauty and the bounty they are blessed with.

This is where **MILKY WAY**, the **EVS** (Environmental Science) book from Sky Education steps in. The books are designed for a student to relate to the world they inhabit. From everyday occurrences like sleeping and clothes to bigger things in life, like saving water and birds, the EVS book is a learner's paradise.

The book is based on 8 major themes, neatly divided into sub topics and related issues. The books are age appropriate and filled with cognitive and gross motor activities.

The core themes of the EVS books are:

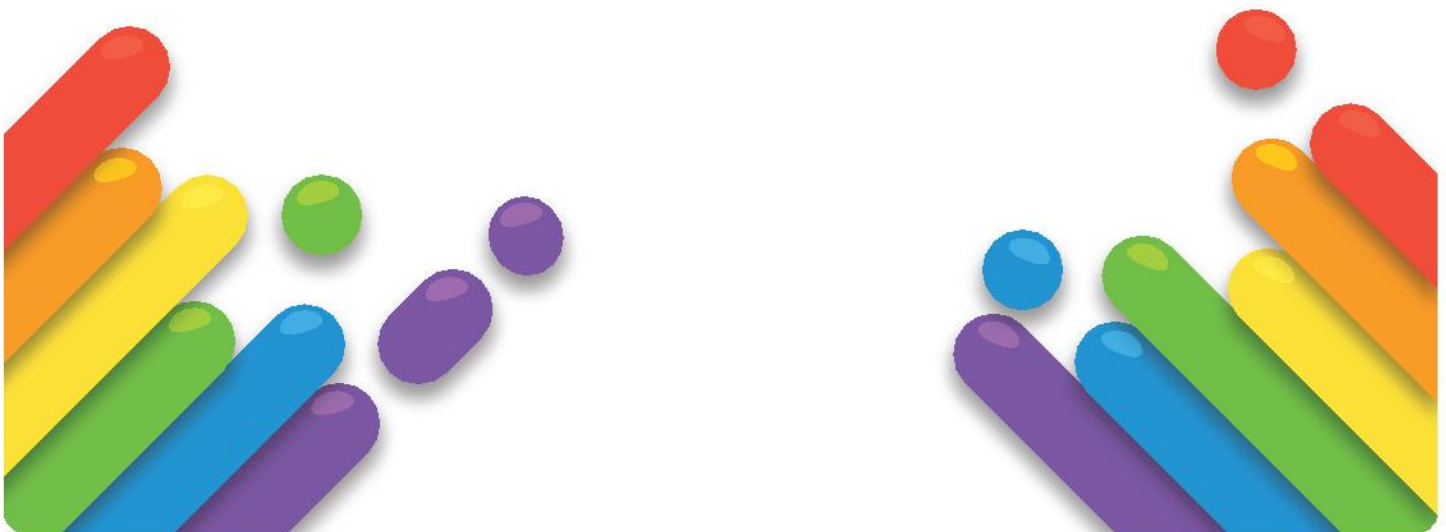

Contents

Theme 01

Why Should I Sleep?



Theme 02

Why Fish don't Sink in Water?

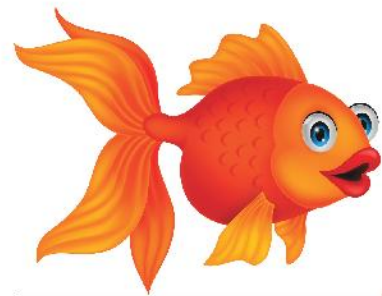

EVS
ENVIRONMENTAL STUDIES

Theme 03

Magic



Theme 04

Why is it difficult to see the sun?



Theme 01

Why Should I Sleep?



Get a Pillow

Circle things that are associated with Sleep



I Sleep in my Bedroom

Find the Hidden Objects



Bed, Key, Blanket, Orange, Moon, Number 6



Do Animals Sleep?

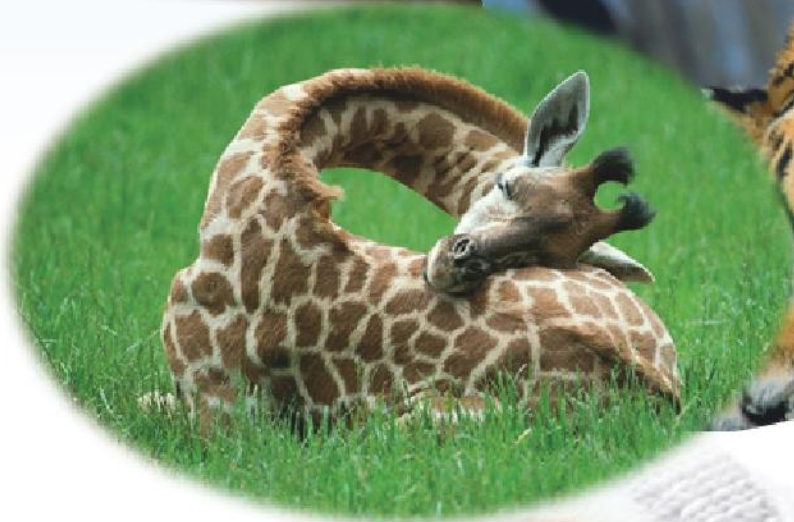

Goodnight Moon



In the great green room
There was a telephone
And a red balloon
And a picture of -
The cow jumping over the moon
And there were three little bears
sitting on chairs
And two little kittens
And a pair of mittens
And a little tov house
And a young mouse
And a comb and a brush and a bowl
full of mush
And a quiet old lady who was
whispering "hush"
Goodnight room
Goodnight moon

Goodnight cow jumping over
the moon
Goodnight light
And the red balloon
Goodnight bears
Goodnight chairs
Goodnight kittens
And goodnight mittens
Goodnight clocks
And goodnight socks
Goodnight little house
And goodnight mouse
Goodnight comb
And goodnight brush
Goodnight nobody
Goodnight mush
And goodnight to the old lady
whispering "hush"
Goodnight stars
Goodnight air
Goodnight noises everywhere.



Hush Little Baby

Hush, little baby, don't say a word
Papa's going to buy you a mockingbird

If that mockingbird won't sing
Papa's going to buy you a diamond ring

If that diamond ring turns brass
Papa's going to buy you a looking glass

If that looking glass gets broke
Papa's going to buy you a billy goat

If that billy goat won't pull
Papa's going to buy you a cart and bull

If that cart and bull turn over
Papa's going to buy you a dog named
Rover



If that dog named Rover won't bark
Papa's going to buy you a horse and
cart

If that horse and cart fall down
You'll still be the sweetest little baby
in town

So hush little baby, don't you cry
Your Mama loves you and so do I



Etiquettes of Sleeping

1. Maintain a regular and consistent sleep schedule.
2. Plan some quiet time before bed ; read a book but avoid watching videos before sleeping
3. Don't go to bed hungry
4. Wash your body before going to bed.
5. Wear clean and comfortable night wears to sleep
6. Don't eat too much before going to bed
7. Calling on the telephone or mobile phone after a certain time at night is rude. Free your bedroom from noises and ringtones.
8. Brush your teeth before and after sleeping
9. Try to sleep early at night and wake up early in the morning
10. Donot disturb someone sleeping



Word Search

L	E	G	H	M	Z	A	R	D	M
T	W	E	W	L	V	Q	A	E	P
P	S	S	E	N	O	Q	N	L	L
O	X	E	E	U	I	O	A	Z	H
N	E	D	E	R	T	Y	H	N	L
E	F	D	S	P	C	I	N	C	P
T	I	B	B	A	R	D	I	A	S
R	S	E	R	F	E	N	R	X	A
Q	R	E	E	T	A	J	S	A	W
E	B	S	V	N	D	T	K	B	E

PLAY

RABBIT

RAN

RED

RIDE

RUN

SAID

SAW

SCHOOL

SEE



Do plants sleep?



Observe the picture



**What does the picture speak?
Comment on the boy's health.**

What will you suggest the boy, looking his eyes?



Estimate - How long do you sleep?

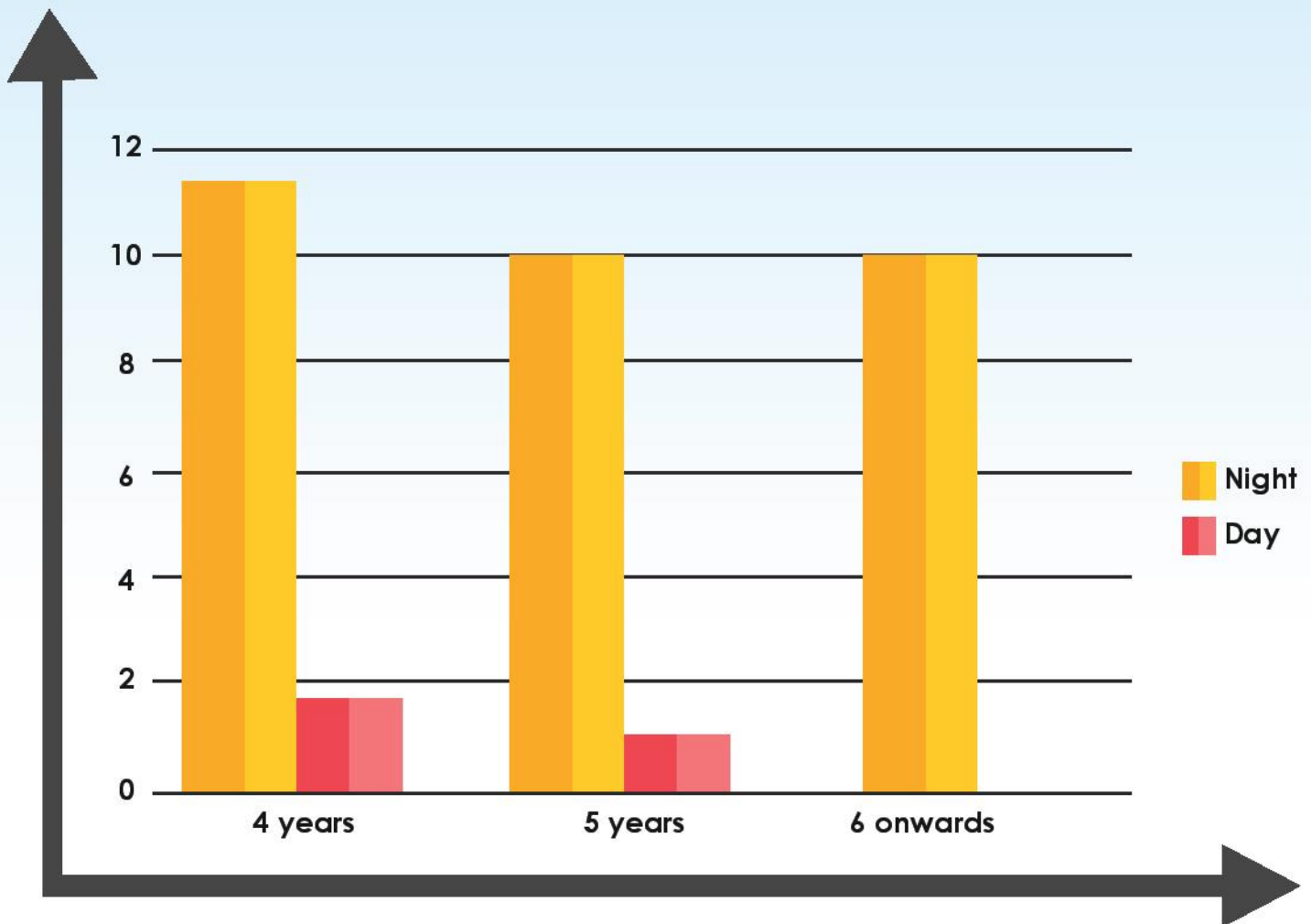

How old are you?

Check the graph and know your age bar

How much should you sleep?

Ask your parents, how long you actually sleep?



Poster Making

Early to bed, early to rise makes a man healthy wealthy and wise



What if we don't sleep?



MEMORY LOSS



**WEIGHT
FLUCTUATION**



**HEART
DISEASE**



**WEAK IMMUNE
SYSTEM**



**HIGH BLOOD
PRESSURE**



Theme 02

Why Fish don't Sink in Water?

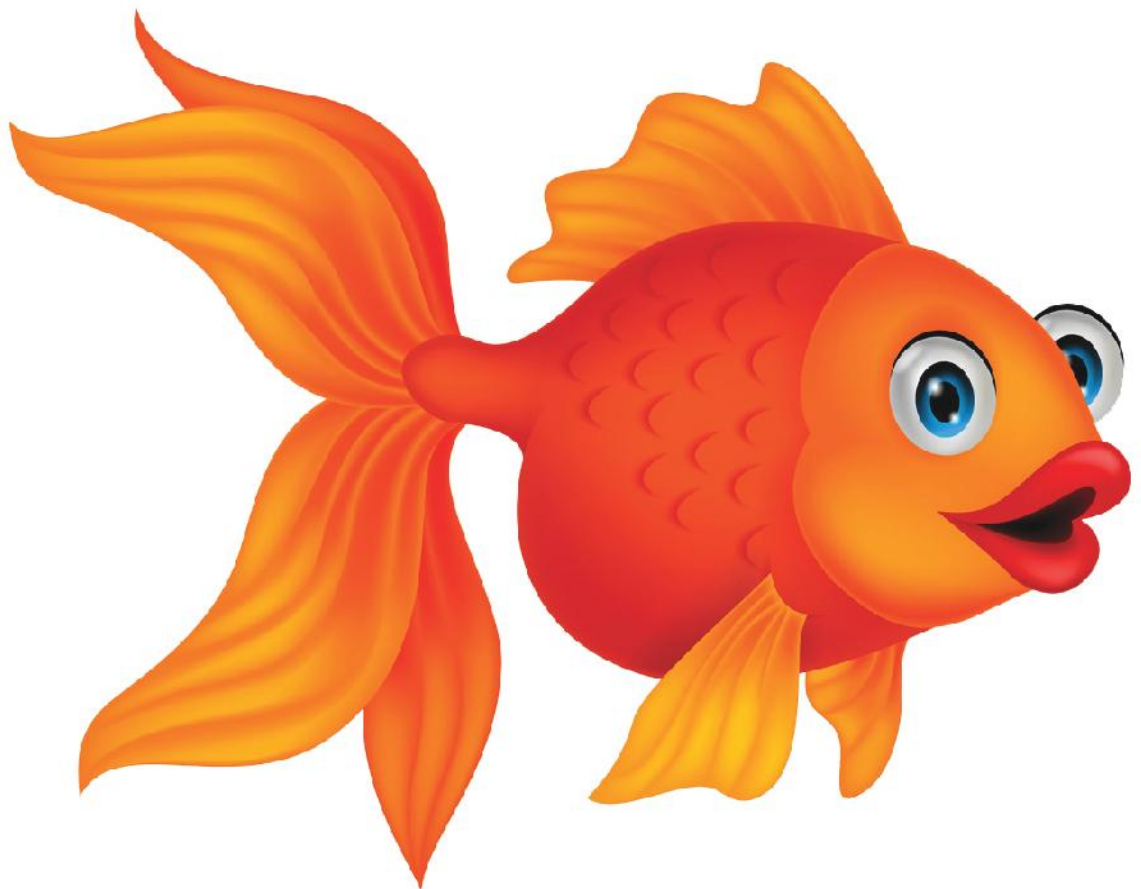

Baa Baa Black Sheep

Look at the picture and share your observation



Floating

The ball is floating



The boy is also floating



The Dolphin and The Shark

Once upon a time, not so long ago, there lived a shark named Simon and a dolphin named Dudley. They lived in the ocean, not too far from a beautiful sandy beach, a tall lighthouse, and a dark, murky swamp. Now Simon and Dudley knew each other, but they weren't the best of friends!

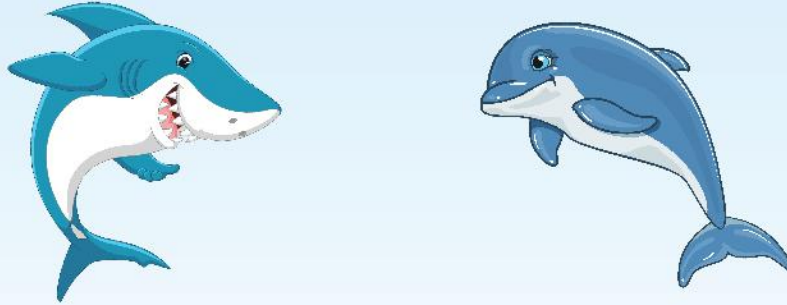

Dudley had two sisters, and they played together but Simon swam alone. Simon's favorite thing was to attack and bite Dudley and his sister's tail! But the dolphins always saw him coming, and they would come up out of the water, and stand on their tails, and whistle and giggle, the way dolphins do, and they always managed to keep just out of reach of Simon's big sharp teeth.

One day, while Dudley was swimming by himself, and Simon was chasing him, they got very close to the shore. Dudley leaped out of the water with Simon right behind him, and they both saw a big green alligator. There, coming out of the swamp, was a frog. And over there, walking towards them up the beach was a raccoon. All of them were so happy to meet one another. They played the entire day and went back to their home at night.



Simon had been thinking especially hard about what had occurred. He had seen three very different creatures getting along well, and being the best of friends.

Simon thought about how lonely his life was, swimming all alone, with no friends, and being grumpy. He had thought very, very hard about these things. And so, he decided what he must do, and he turned slowly toward the dolphin, and swam very slowly up to him, and began to tell him what he thought.

The next morning, Simon was playing with the three dolphins and not attacking them

Now they all swam together, and played together, and took care of one another, and were very happy.



Three Little Fish

Connect dot to dot

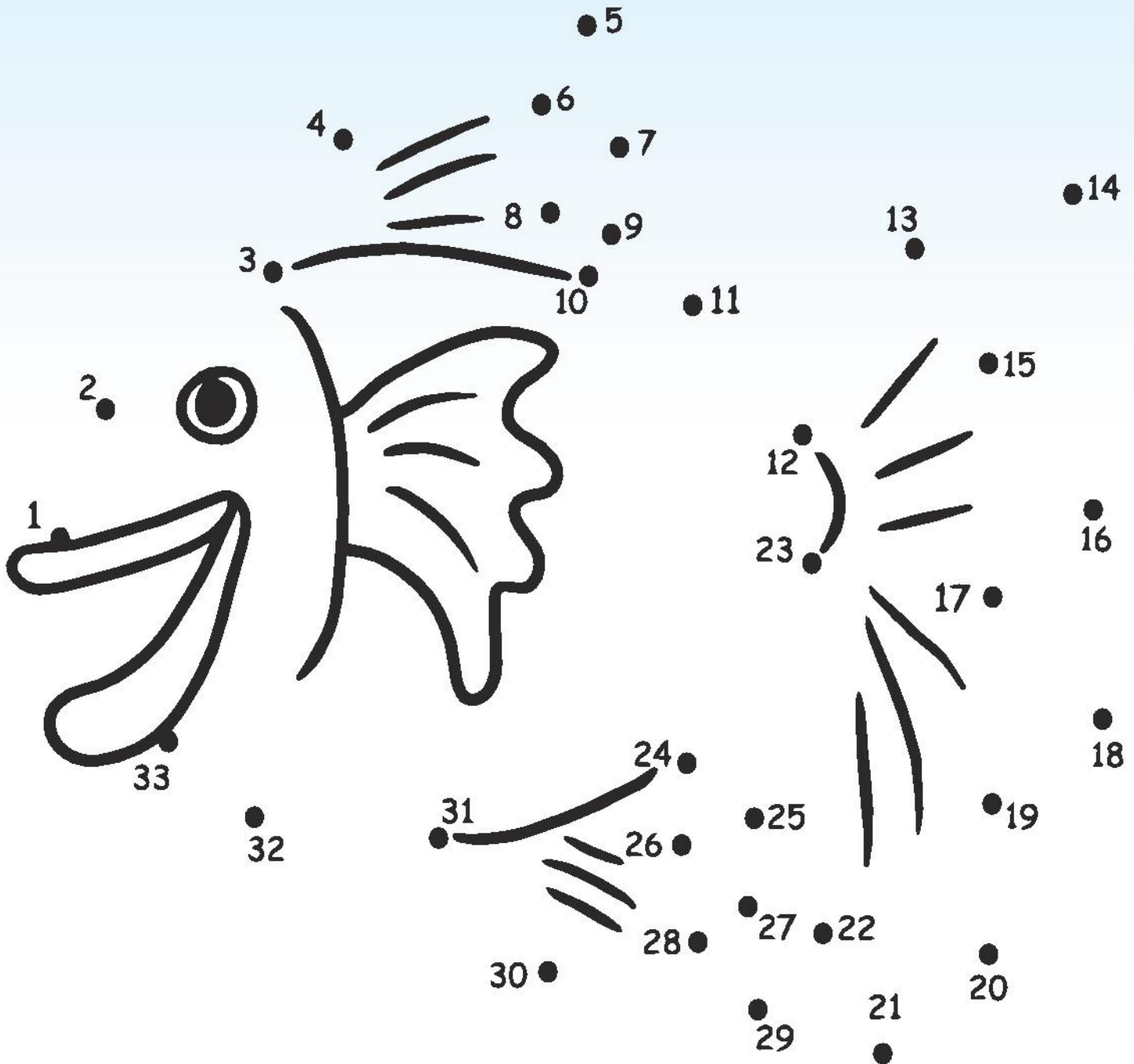

Fish Maze

The goldfish needs to go into its bowl. Draw a path through the maze to the fish starting at 1 and counting by 1 up to 20

Re Make!!!

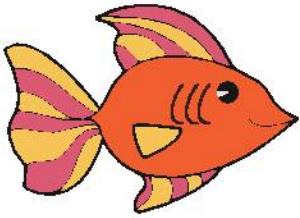
1	2	3	10	11	12	13	14		
		4	9	8	21	16	15		
		5	6	7	22	17	18	19	20

Draw a Fish:-



Recognise the Aquatic animals



Fish

crab

Prawn

Clam

Octopus

Tortoise

Frog



Experiment - Float and Sink



Float	Sink



Circle the things that will Sink



Orange



Lava Rock



Marble



Nail

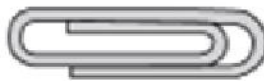

Paperclip



Pencil



Carrot



Leaf



Soap

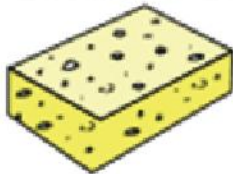

Sponge



Rock



Stick or Twig



Sinker

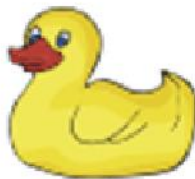

Rubber Ducky



Boat



Apple



Penny



Crayon



Water Relay

Which Mug will float? What are they made up of?



Fish Quiz

What is Wrong with the picture?



Visit to a Fish Market

**Fish doesn't float in Fish Market!
When do fish sink in water?**



28



In the middle of the sea - Life Jacket



SINK or FLOAT?

Circle the objects that can float and draw a square around the objects that would sink.

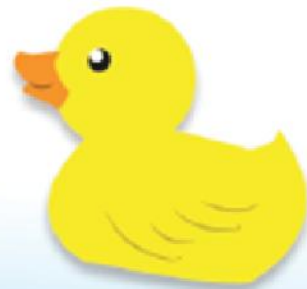
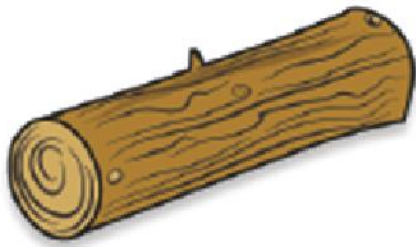

Theme 03

Magic



Recreate (Spatial Learning)

Do you know the story of **The Wizard of Oz**

"The road to the city of Emeralds is paved with yellow brick," said the Witch, "so you cannot miss it. When you get to Oz do not be afraid of him, but tell your story and ask him to help you. Goodbye, my dear."

Meet the loveable **Scarecrow**, the rusty **Tin Woodman** and Cowardly **Lion** as they join **Dorothy**, the brave girl in her quest to ask the Great Wizard of Oz for help.



But not without facing the dangers of the Wicked Witch of the West and her flying monkeys, deadly poppyfields and "bears with heads like tigers" along the way!

Make your own story from the characters in the picture.
Can you name the characters from the mask?



Colour (Creative Thinking)

The Wizard is making his magic potion.
Can you add colours to the pot?



Size (Numeracy)

Wizards and Witches comes in all shapes and sizes. Arrange these from the smallest to the biggest.





Show Time (Creative Thinking)

Harry Potter is the most famous magician in the world. Watch the movie Harry Potter and the Philosopher's Stone.



Find all the characters from the clues given.



Harry Potter

Dolby, the house elf

Hagrid

Harry Potter

Griffindor Hat

Broom Nimbus

Porfessor Snape

Ron Weasley

Potter Scarf



Think (Logical Thinking)

Let's make a Magic Potion

The Wizard has got it all mixed up. He forgot which comes first.



Drink
Mix Sugar
Boil it
Take a Cup
Add Water



The Magic Tree

A long, long time ago a little boy was walking through a park. In the middle of the park there was a tree with a sign on it. The sign **said "I am a magic tree. Say the magic words and you will see."**



The boy tried to guess the magic words. He tried abracadabra, supercalifragilisticexpialidocious, tan-ta-ra, and many more... but none of them worked.



Exhausted, he threw himself on the floor, saying: **"Please, dear tree!"** and suddenly, a big door opened in the trunk. Inside everything was dark, except for a sign which said "Carry on with your magic."

Then the boy said "Thank you, dear tree!" With this, the inside of the tree lit up brightly and revealed a pathway leading to a great big pile of toys and chocolate.

The little boy brought all his friends to the magic tree, and they had the best party ever. This is why people always say that "please" and "thank you" are the magic words.

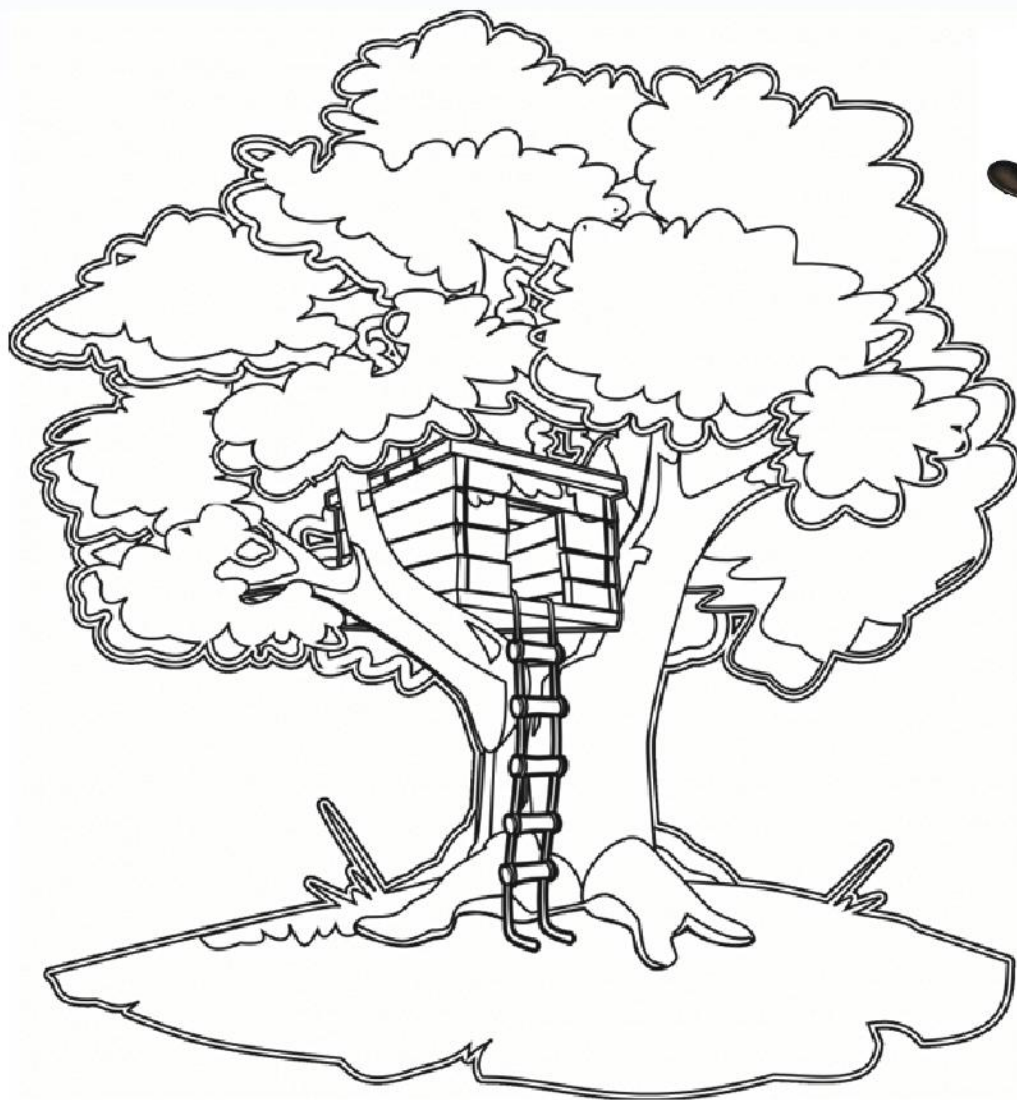

Discover (Global Perspective)

Animals used by the Magicians

Match the animals used by the magicians with the place they live in

Owl
Rabbit
Mouse
Frog
Dragon



Owl
Rabbit
Mouse
Frog
Dragon



44





How does the magician pull of a RABBIT from a hat?

Can you perform the trick?



My Magic Hat is Marvelous

My magic hat is marvelous.
It's round and rather red.
It looks just like a baseball cap
and sits atop my head.



The things it does are magical;
It helps to keep me warm,
and keep my head from getting wet
whenever there's a storm.

It's magic how it shades my eyes
and holds my hair in place.
And if I wear it backwards,
it reveals my smiling face.

It's magically adjustable;
just pull the little strap.
And yet, it looks exactly
like a normal baseball cap.

Its powers are mysterious.
You simply have to see.
I'll gladly let you look
for just a small fee.



What house is our elf from?

Cut out this sorting hat and place it on elf's head
and later on the house of your elf will be revealed!

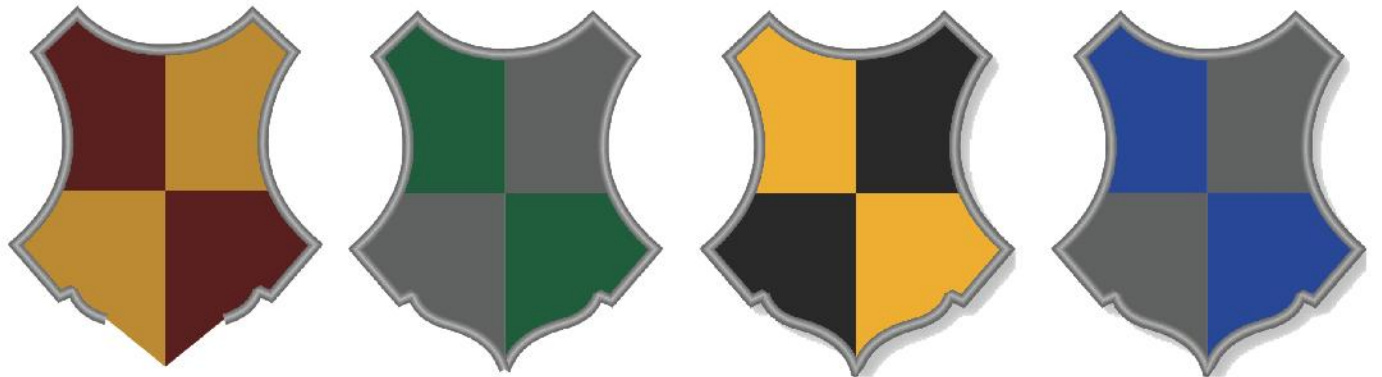
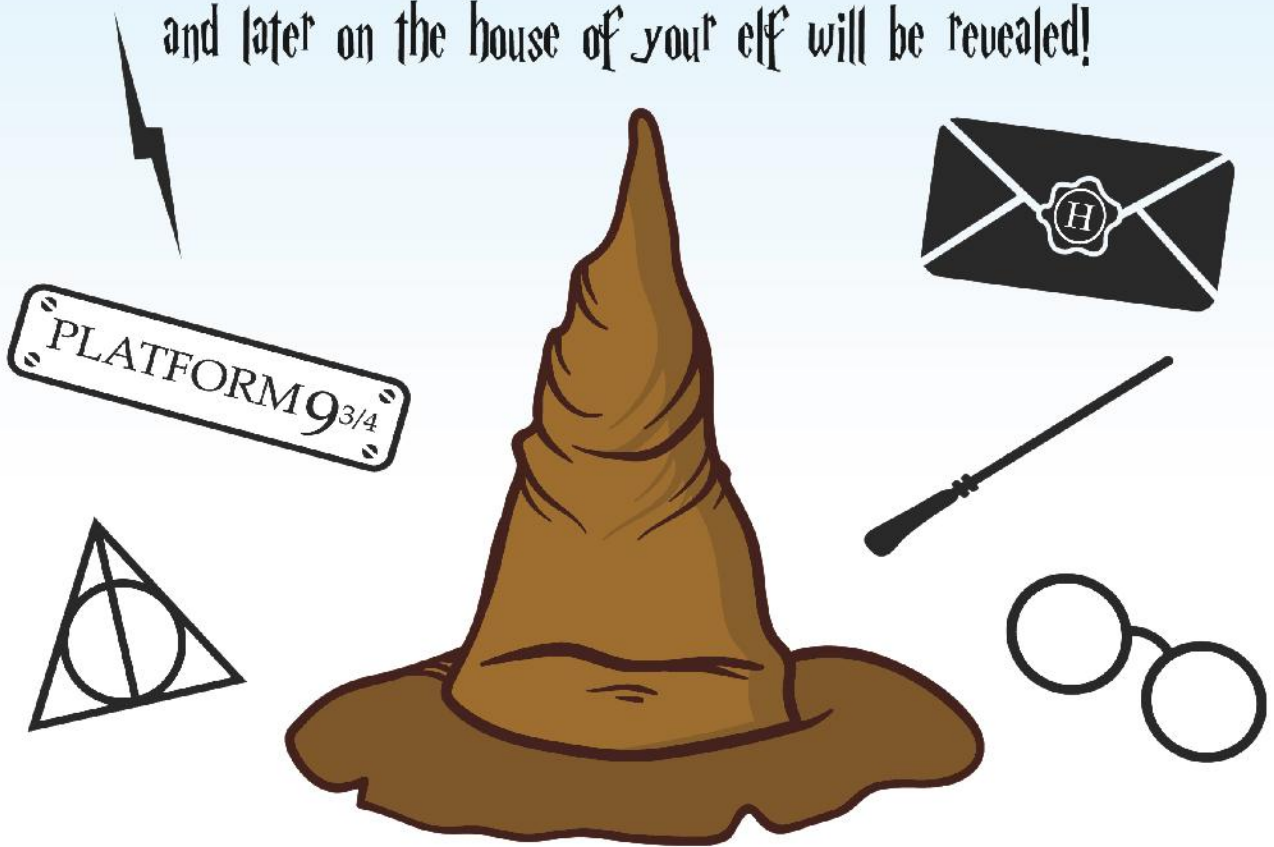

Theme 04
Why is it difficult to
see the sun?



Where is the Sun?

Search The Word Sun (5) In The Grid

S	U	N	A
M	S	O	S
O	U	U	N
O	N	U	S
N	S	A	T



Who shine brighter?

One night stars went near the moon and said, "Can you tell who shines brighter?"

Moon said proudly, "It's obviously me"

Stars started smiling and said "Oh no ! Its not you, its we".

Moon said, "No,its m".

The stars said, "Ok, lets ask the children"

They went near one window and asked the children to tell us who shines brightly.

Children said, "Moon"

Suddenly one big cloud came in front of moon, then children said Stars".

When cloud disappear they again said, "Moon"

The stars said, "Lets go to some other person"

They both went to another window and saw one old man. They asked him to tell who shines brighter.

Old man said, "Oh, its very difficult for me to tell because I am too old so. I can't see clearly. So, please I am sorry I can't help you".



Then they went to another window where they saw one mother was singing a song for her baby so that he could get sleep. The moon and stars asked her to tell who is brighter among us. She replied that my baby's face is brighter than both of you.

Then they approached Earth. The moon was very happy; he felt that Earth will show him favour.

On asking Earth replied, "It is true that the moon shines brightly in the night and its light is very useful. But my friend! Don't be proudly Remember this light is not your own, you are getting it from the Sun. So don't feel proud on that which is not yours".

The Earth continued, "The twinkling little stars are really not so small They are the buddies of sun because sun itself is also a star. Don't be ignorant, if a few stars come together their heat and light will be unbearable for us. The twinkling of stars also provides beauty to the night. Don't fight with each other." Each one felt satisfied and thanked Earth



Feeling Hot

Observe and tell

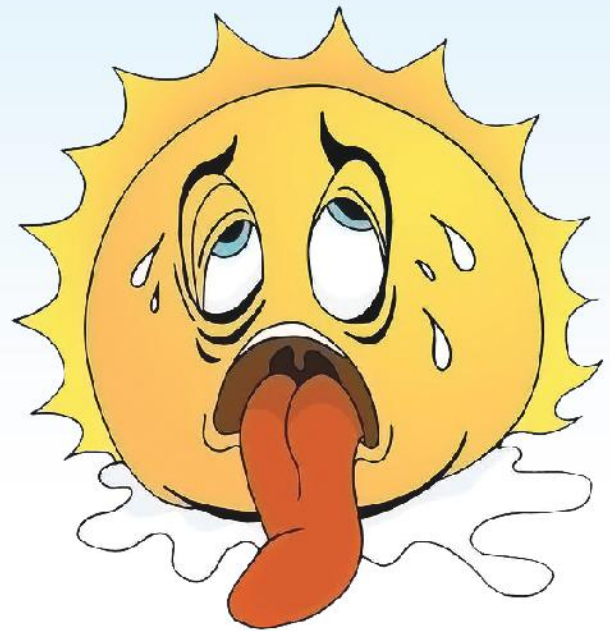

Craft - Sun Mask

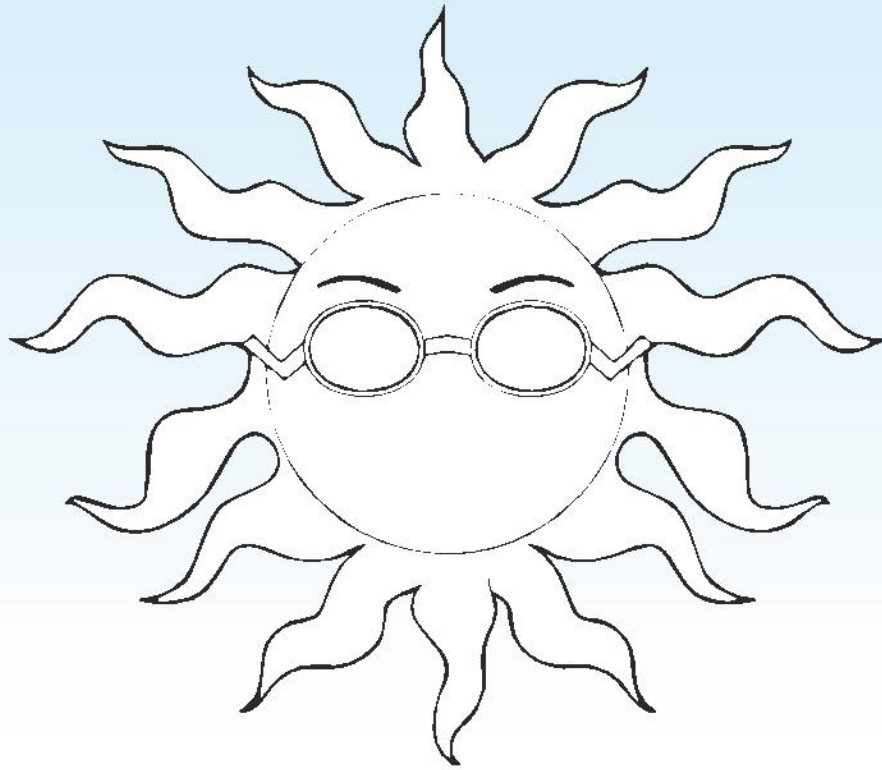

Experiment - Globe and Torch

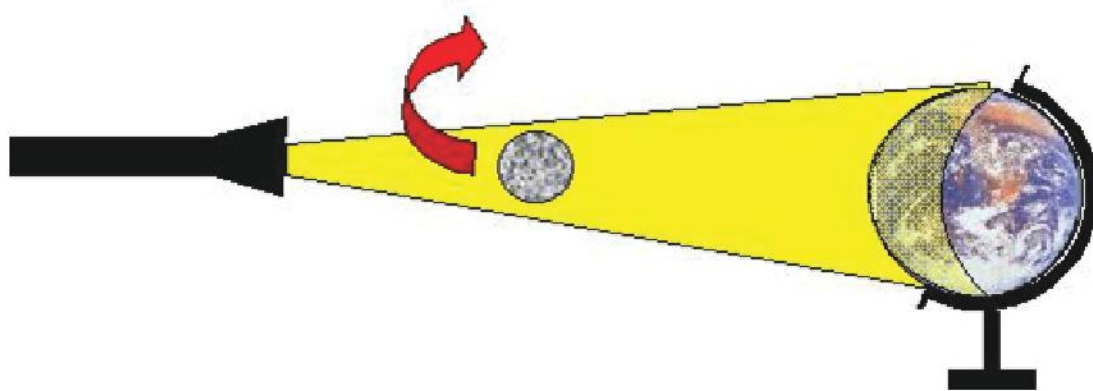
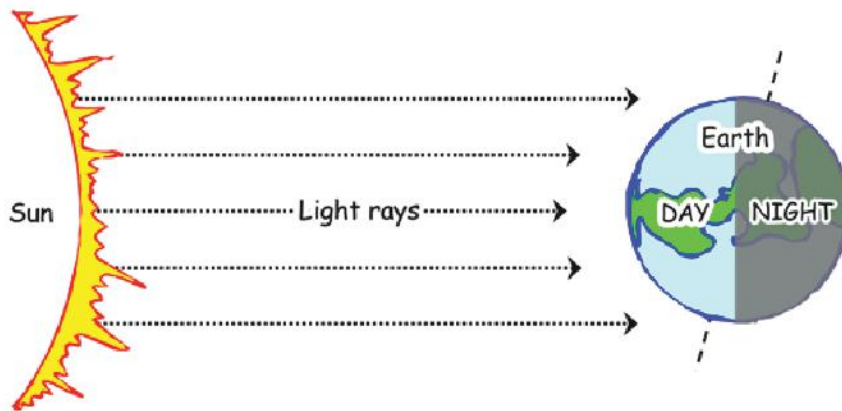

Traffic signal rules

Circle the items that can produce light and heat



Word Smart (Vocabulary Builder)



56



What should I wear when it is hot?

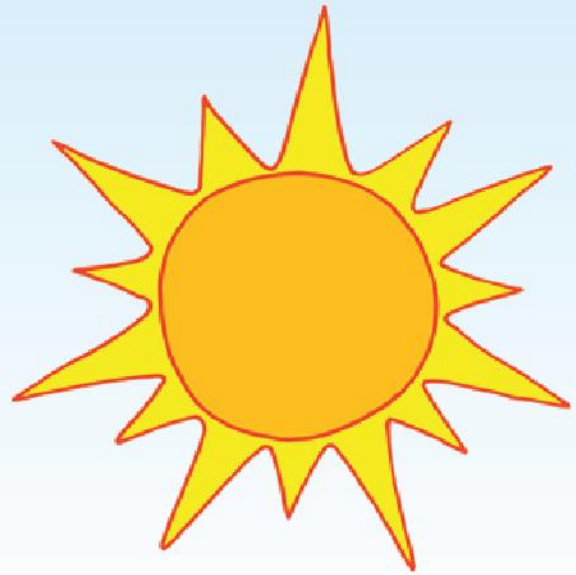

Word Smart (Vocabulary Builder)

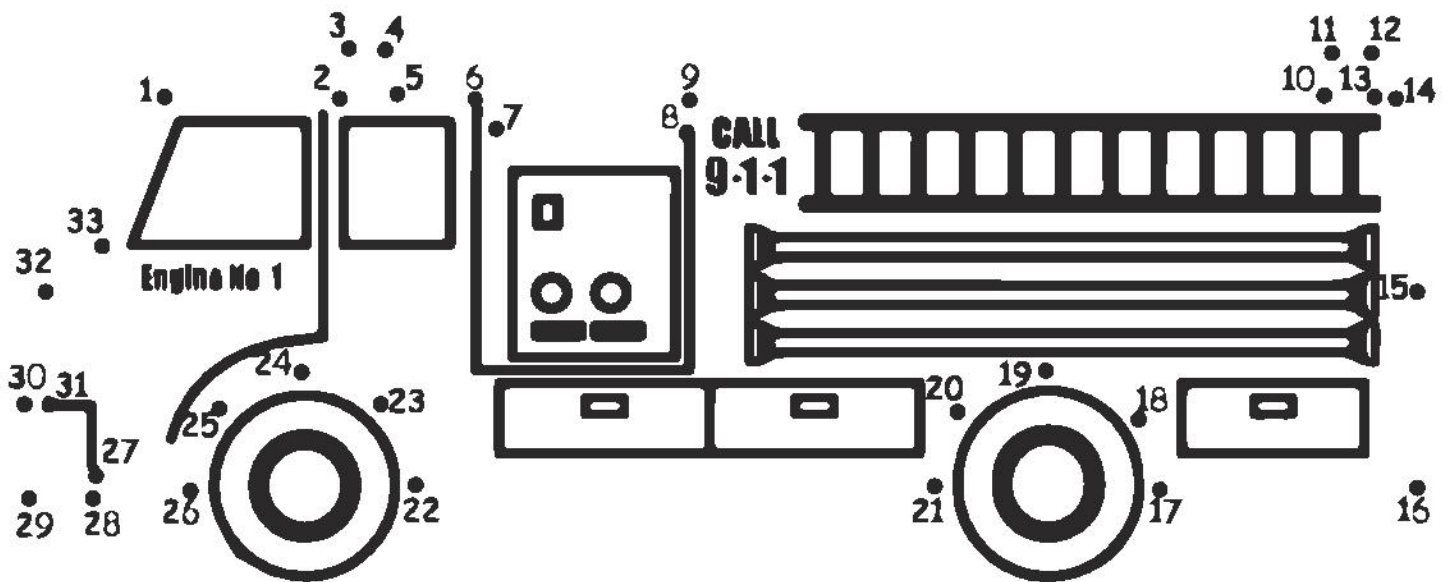

Treasure Hunt

Sun given us Light.

It is easy to find the objects in light

Please recognise at least 10 objects in the picture.



Fact or Fiction

Tick the Facts and cross the Fiction

- Shape of the Sun is round
- Our Moon has its name - Luna
- The Sun is not a star.
- Sun becomes black at night
- The Sun, the moon and the Earth are always moving.
- We can see many stars at night
- The Moon has its own light.
- There is a switch on Earth which on pressing changes Day into night.
- We get light and heat from the Sun
- We live on the planet Earth



Why do we need the Sun?

Colour the hot object with RED.

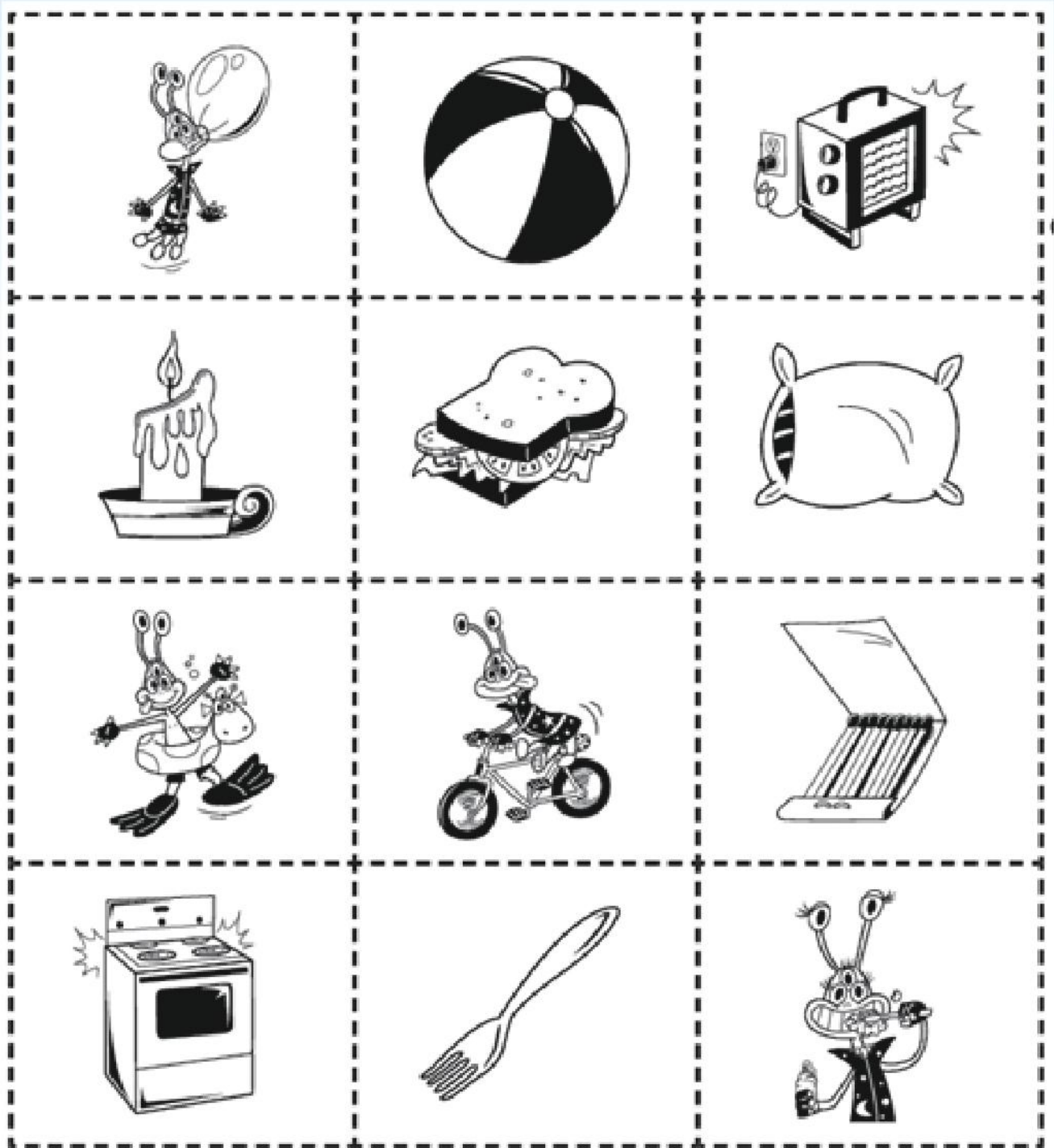

Mark your hand shadow

Why is the shadow dark? It is always black or we can have coloured shadow?



It's Story Time (Literacy)



Using three coloured sources of light - Red, Green and Blue we can create coloured shadows.

